

Article number: 391804407042310

Description: Worm gear with st. steel hollow shaft
VF 44 EP-F2-70- 63B14

Measures

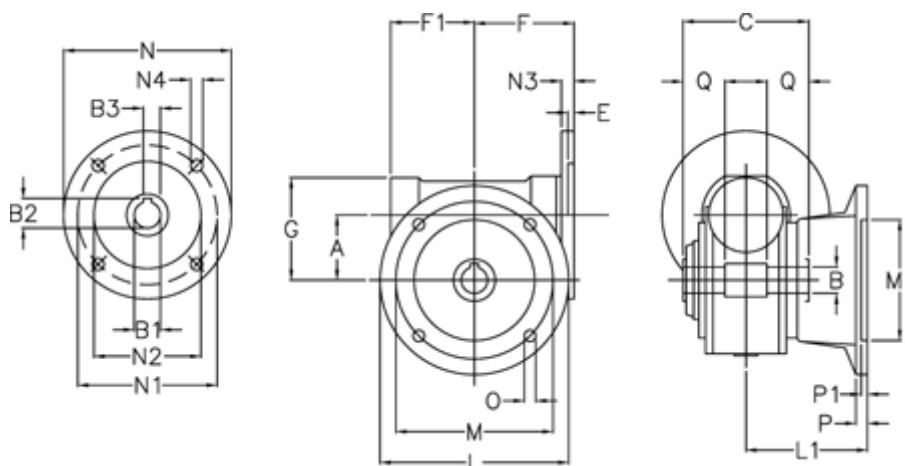

a	= 44.6	F1 = 54	N2 = 60
B	= 18	g = 71	N3 = 8.0
B1 E7	= 11	L = 110	N4 = 5.5
B2	= 12.8	L1 = 60.5	O = 8.5
B3 H9	= 4	m = 87	P = 9
C	= 64	M1 = 60	P1 = 7
E	= 2.0	N = 90	Q = 24.5
F	= 65	N1 = 75	